

New Dimensions
in Motion

SPECIFICATIONS

 **HITACHI**

KH180-3

HYDRAULIC CRAWLER CRANE

Max. Rated Load : 50 000 kg

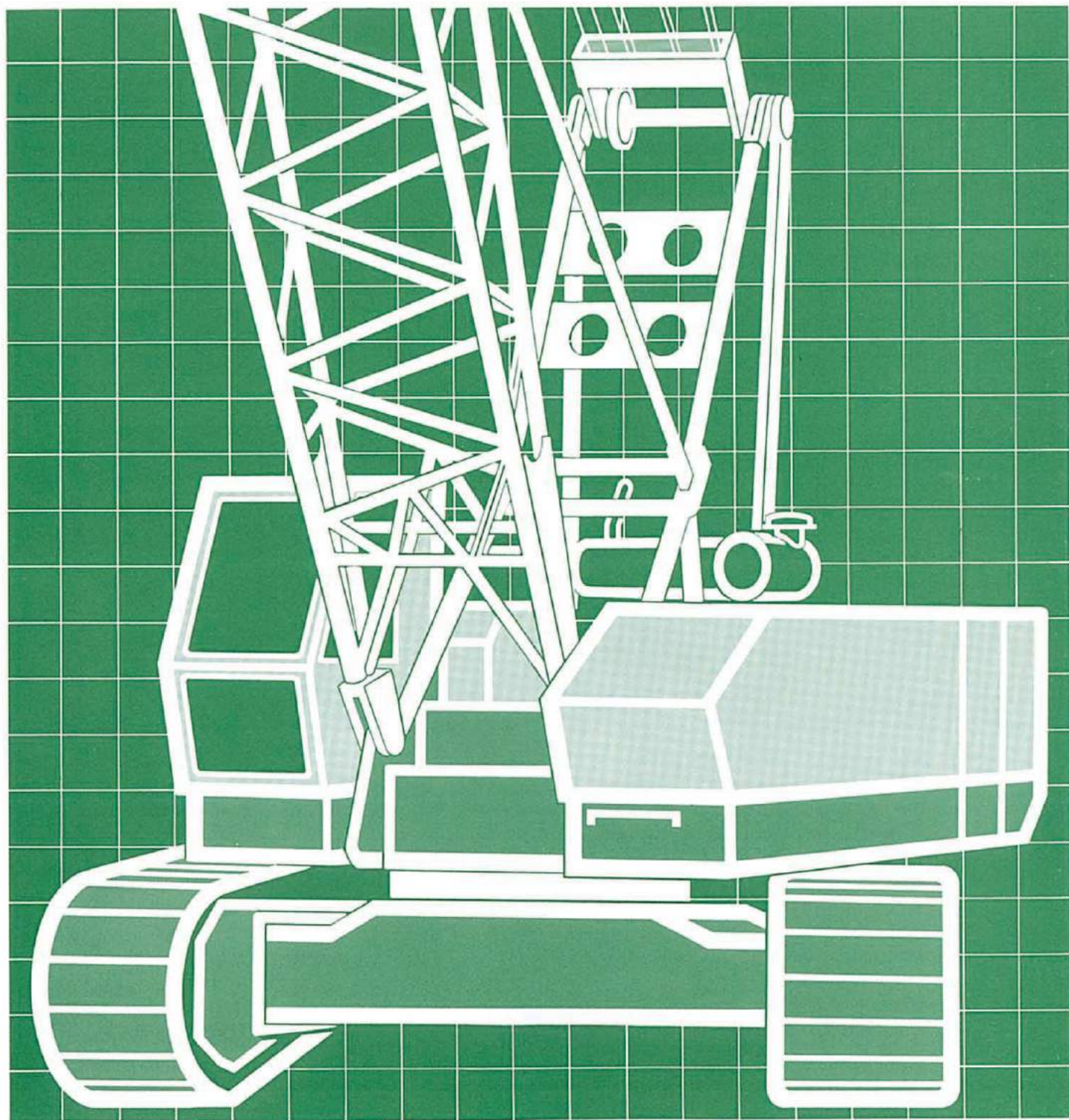

Front Attachments

Basic Machine

STD Basic Machine



Specialized Dragline Machine



Equipped with optional winches to meet excavation work

Boom

TOWER USE



19.0 m – 40.0 m
(62'3" – 131'2")

CRANE USE

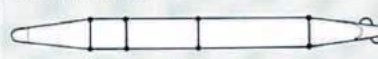

Liftcrane: 13.0 m – 52.0 m
(42'8" – 170'7")
Clamshell: 13.0 m – 19.0 m
(42'8" – 62'4")

Angle Chord Boom



Dragline: 13 m – 19 m
(42'8" – 62'4")

Tower Jib

16.0 m – 28.0 m
(52'6" – 91'9")



15-metric ton hook
for tower crane



Leader



Clamshell

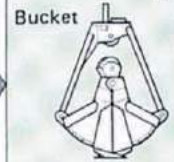

0.8 – 1.2 m³
(1.05 – 1.57 cu yd)



Max. digging depth
36 m (118'1")

Dragline

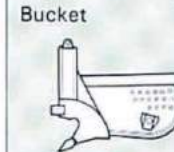

0.8 – 1.0 m³
(1.05 – 1.31 cu yd)



15-metric ton hook



30-metric ton hook



50-metric ton hook



Jib

6.10 m – 15.25 m (20'0" – 50'0")

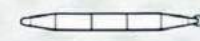

Auxiliary Jib



Jib hook

5-metric ton hook



Power Transmission Mechanism and Hydraulic System

- 1 Variable displacement pump
- 2 Fixed displacement pump
- 3 Fixed displacement motor
- 4 Counterbalance valve
- 5 Brake valve
- 6 Control valve
- 7 Filter
- 8 Hydraulic tank
- 9 Oil cooler
- 10 Engine
- 11 Main hoist drum
- 12 Aux. hoist drum
- 13 Boom hoist drum
- 14 Center joint
- 15 Swing mechanism
- 16 Swing circle
- 17 Travel mechanism
- 18 Drive tumbler
- 19 Operator's cab

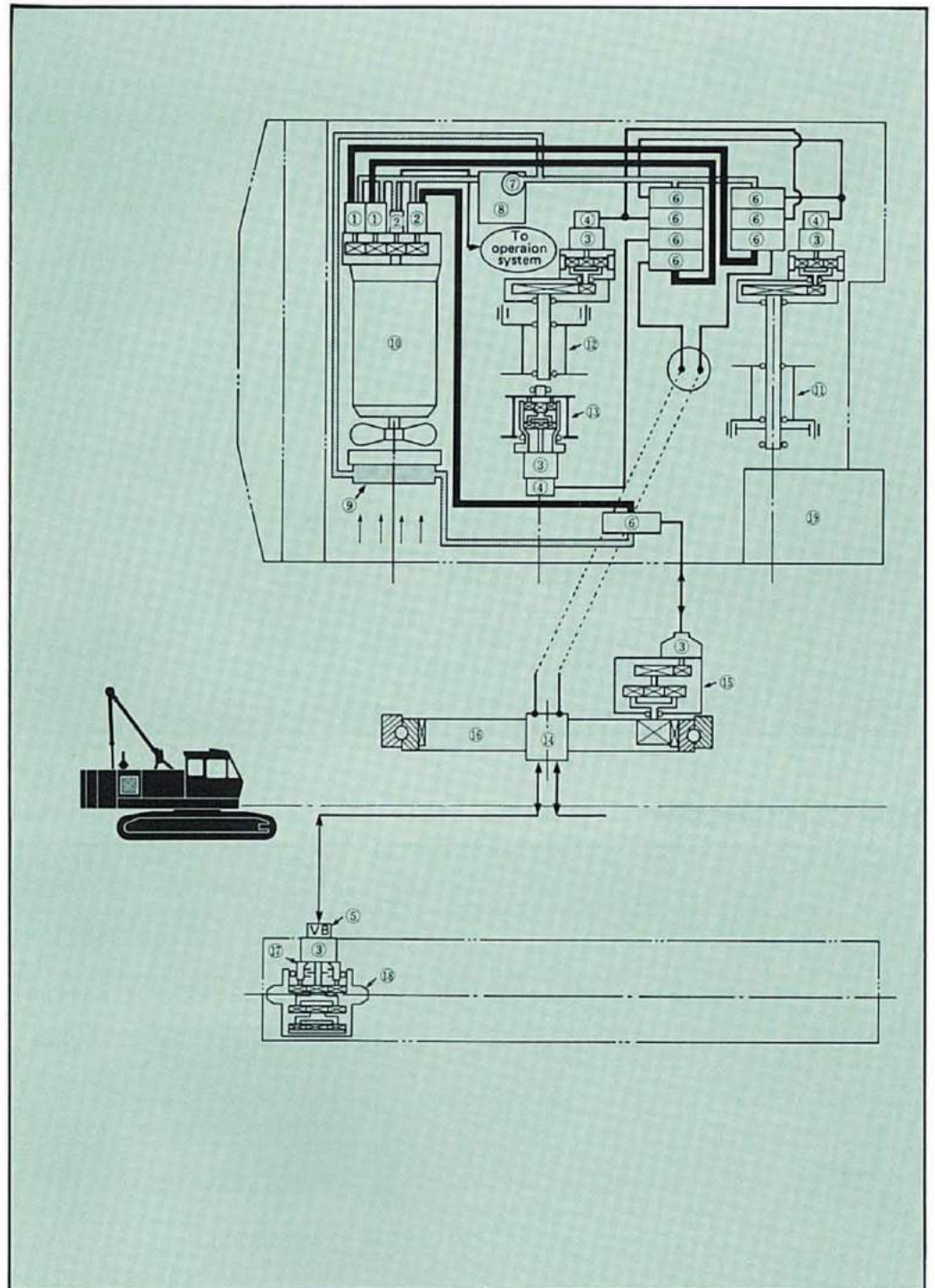

CRAWLER CRANE

With Tubular Chord CRANE Boom

Dimensions

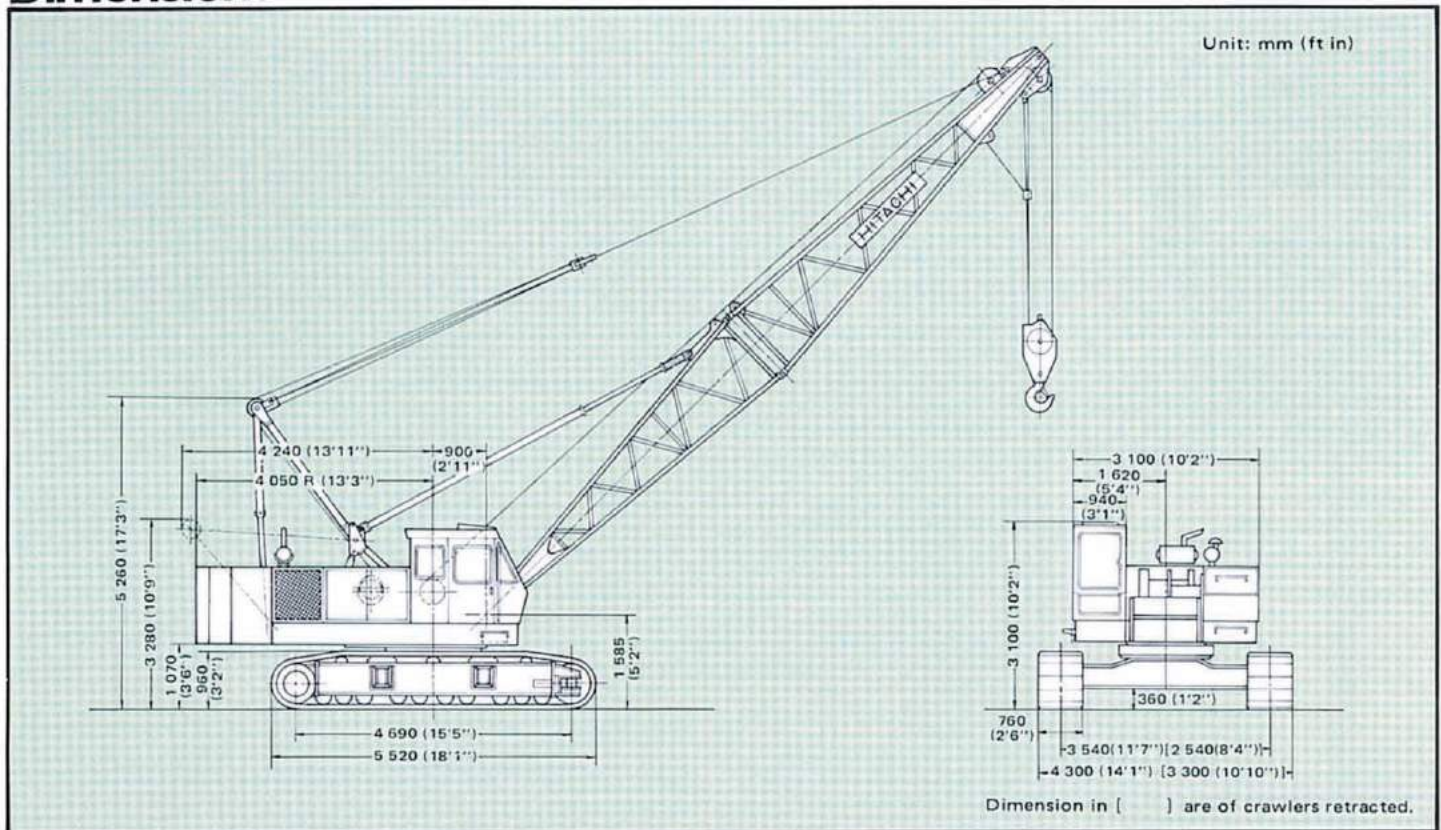

Specifications

Maximum rated load		50 000 kg (110 200 lb) at 3.7 m (12'2") working radius
Boom	Basic boom length	13.0 m (42'8")
	Max. boom length	52.0 m (170'7")
	Jib length	6.10 m (20'0") – 9.15 m (30'0") – 12.20 m (40'0") – 15.25 m (50'0")
	Max. boom length with jib	58.25 m (191'1") [43.0 m (141'0") + 15.25 m (50'0")]
Swing speed		0 – 3.5 min ⁻¹ (0 – 3.5 rpm)
Travel speed		0 – 1.5 km/h (0.93 mph)
Gradeability		22° (40%)
Ground pressure		0.61 bar (0.61 kgf/cm ² , 8.67 psi)
Operating weight	Equipped with basic boom, 50 000 kg (110 200 lb) capacity hook and 15 900 kg (35 100 lb) counterweight	46 900 kg (103 000 lb)
Engine	Model	HINO EM100
	Rated horsepower	110 kW (150 PS) at 2 000 min ⁻¹ (2 000 rpm)

HOOKS

Capacity	Weight	Number of hoist reeving and maximum rated loads									
		9	8	7	6	5	4	3	2	1	
50 000 kg (110 200 lb)	570 kg (1 250 lb)	50 000 kg (110 200 lb)	44 800 kg (98 800 lb)	39 900 kg (87 900 lb)	34 200 kg (75 400 lb)	28 500 kg (62 800 lb)	22 800 kg (50 300 lb)	17 100 kg (37 700 lb)	11 400 kg (25 100 lb)		Standard for main boom
30 000 kg (66 100 lb)	330 kg (730 lb)				30 000 kg (66 100 lb)	28 500 kg (62 800 lb)	22 800 kg (50 300 lb)	17 100 kg (37 700 lb)	11 400 kg (25 100 lb)		Optional for main boom
15 000 kg (33 100 lb)	280 kg (620 lb)							15 000 kg (33 100 lb)	11 400 kg (25 100 lb)		
5 000 kg (11 000 lb)	130 kg (290 lb)									5 000 kg (11 000 lb)	Optional for jib or aux. jib

DRUMS

Dimensions

	Rope dia.	Width	Drum p.c.d.	Max. rope capacity
Main hoist drum	20 mm (0.787")	369 mm (14.53")	420 mm (16.54")	267 m (876')
Aux. hoist drum	20 mm (0.787")	306 mm (12.05")	420 mm (16.54")	220 m (722')

Line speed and line pull

	Max. line speed m/min (ft/min)				Effective line pull	@	Line speed	Max. starting line pull	Max. running line pull
	Hoisting		Lowering						
Main hoist drum	H	70 (230)	H	70 (230)	108 kN (11 000 kgf) (24 300 lbf)	@	34 m/min (112 ft/min)	140 kN (14 300 kgf) (31 600 lbf)	153 kN (15 600 kgf) (34 400 lbf)
	L	35 (115)	L	35 (115)					
Aux. hoist drum	H	70 (230)	H	70 (230)	108 kN (11 000 kgf) (24 300 lbf)	@	34 m/min (112 ft/min)	140 kN (14 300 kgf) (31 600 lbf)	153 kN (15 600 kgf) (34 400 lbf)
	L	35 (115)	L	35 (115)					

H: High speed range L: Low speed range

- Notes: 1) Line speed and line pull are based on first layer of winding at rated engine rpm.
 2) Hoisting line speed varies with load.
 3) Line pull is based on a single line pull in high speed range.
 4) Effective line pull is equivalent to available line pull of mechanical drive winch.

- 5) When starting, hydraulic motor is without rotating, the line pull is "Max. starting line pull" After motor rotating, the line pull becomes "Max. running line pull" shortly.

BOOM HOIST DRUM

Rope diameter	Hoisting line speed	Lowering line speed
16 mm (0.63")	60 m/min (197 ft/min)	60 m/min (197 ft/min)

Working Ranges

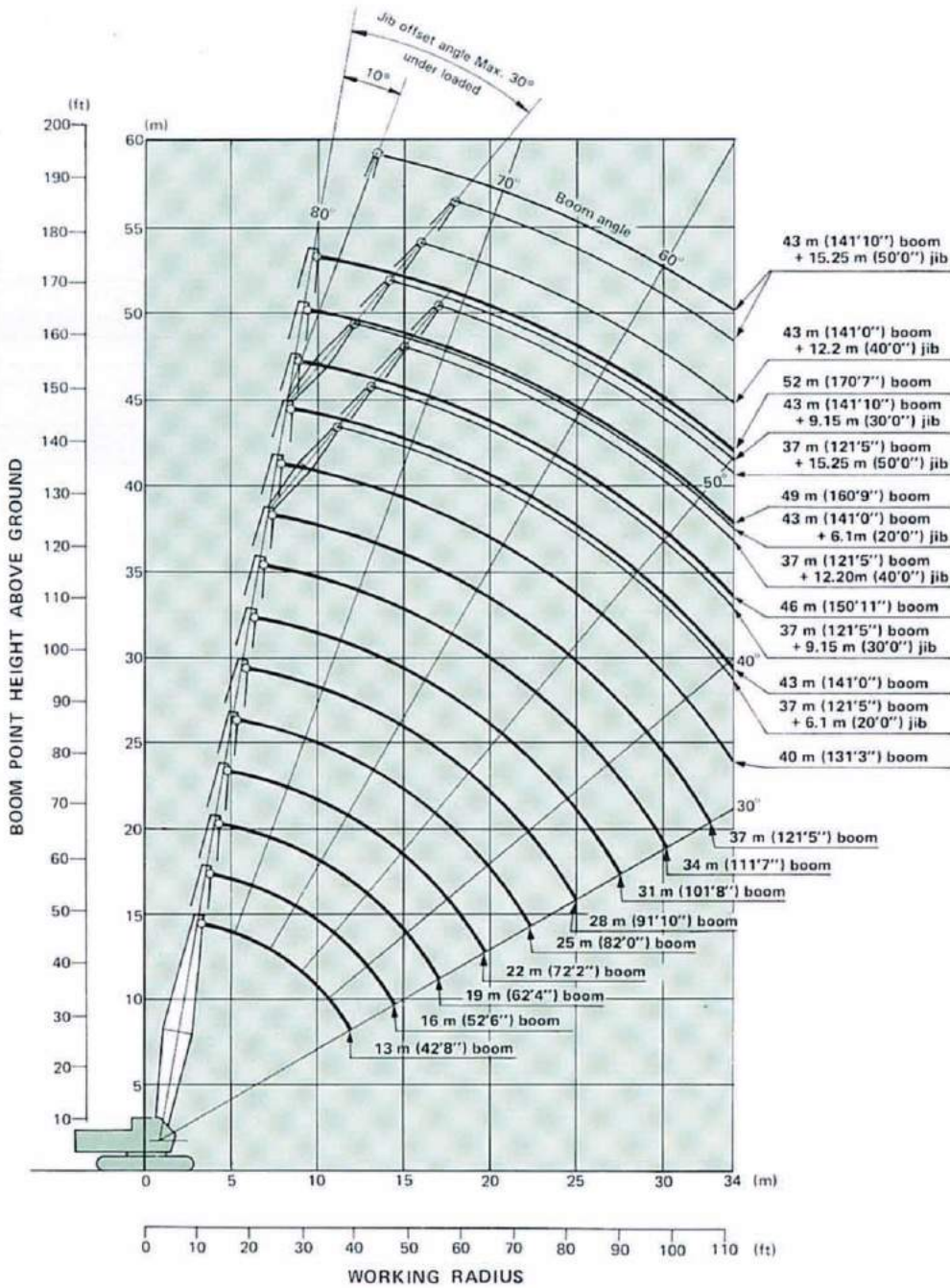

HOOK CLEARANCE

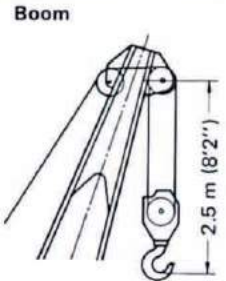

50 000 kg (110 200 lb)
Capacity hook

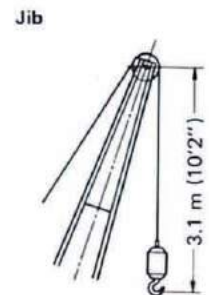

5 000 kg (11 000 lb)
Capacity hook

See page 12, for construction

Crane Ratings

BS Rating:

The rated loads are determined according to BS (British Standard, 1981) and the machine is stationed on firm level ground.

PCSA Rating:

The rated loads, listed are determined according to PCSA (Power Crane and Shovel Association in U.S.A.) and do not exceed 75% of tipping load on condition that the machine is stationed on firm, level ground.

JIS Rating:

The rated loads shown don't exceed 78% of tipping loads with the machine on firm level ground.



Tubular Chord CRANE Boom in 360° Working Area

Boom length	Working radius		Boom angle	Rated load				
				JIS rating	BS rating		PCSA rating	
m (ft in)	m	ft in	degree	kg	kg	lb	kg	lb
13.0 (42'8")	3.7	12' 2"	78.67	50 000	50 000	110 200	50 000	110 200
	4.0	13' 1"	77.31	45 800	45 800	100 900	43 600	96 100
	4.5	14' 9"	75.03	38 600	37 900	83 500	35 650	78 500
	5.0	16' 5"	72.72	32 100	32 000	70 500	30 100	66 300
	5.5	18' 1"	70.38	27 600	27 600	60 800	26 000	57 300
	6.0	19' 8"	68.01	24 600	24 250	53 400	22 850	50 300
	7.0	23' 0"	63.12	19 500	19 450	42 800	18 350	40 400
	8.0	26' 3"	58.00	16 200	16 200	35 700	15 300	33 700
	9.0	29' 6"	52.57	13 800	13 800	30 400	13 050	28 700
	10.0	32'10"	46.68	12 100	12 050	26 500	11 350	25 000
	12.0	39' 4"	32.49	9 500	9 500	20 900	9 000	19 800
12.3	40' 4"	30.00	9 250	9 200	20 200	8 750	19 200	
16.0 (52'6")	4.1	13' 5"	79.36	44 200	44 200	97 400	41 500	91 400
	4.5	14' 9"	77.89	38 550	37 800	83 300	35 550	78 300
	5.0	16' 5"	76.05	32 000	31 900	70 300	30 000	66 100
	5.5	18' 1"	74.19	27 500	27 500	60 600	25 900	57 100
	6.0	19' 8"	72.31	24 500	24 150	53 200	22 750	50 100
	7.0	23' 0"	68.49	19 400	19 350	42 600	18 250	40 200
	8.0	26' 3"	64.56	16 100	16 050	35 300	15 150	33 400
	9.0	29' 6"	60.48	13 700	13 700	30 200	12 950	28 500
	10.0	32'10"	56.24	12 000	11 900	26 200	11 250	24 800
	12.0	39' 4"	46.97	9 400	9 350	20 600	8 850	19 500
	14.0	45'11"	35.95	7 800	7 650	16 800	7 250	15 900
14.9	48'11"	30.00	6 800	6 800	14 900	6 750	14 800	

Continued on next page. ➤

Boom length	Working radius		Boom angle	Rated load				
				JIS rating	BS rating		PCSA rating	
	m (ft in)	m	ft in	degree	kg	kg	lb	kg
19.0 (62'4")	4.6	15' 1"	79.53	36 800	36 300	80 000	34 150	75 200
	5.0	16' 5"	78.29	31 900	31 850	70 200	30 000	66 100
	5.5	18' 1"	76.74	27 400	27 400	60 400	25 850	56 900
	6.0	19' 8"	75.18	24 400	24 150	53 200	22 750	50 100
	7.0	23' 0"	72.03	19 300	19 300	42 500	18 200	40 100
	8.0	26' 3"	68.81	16 000	16 000	35 200	15 150	33 400
	9.0	29' 6"	65.52	13 600	13 600	29 900	12 900	28 400
	10.0	32' 10"	62.14	11 900	11 850	26 100	11 200	24 600
	12.0	39' 4"	55.01	9 300	9 300	20 500	8 800	19 400
	14.0	45' 11"	47.17	7 700	7 550	16 600	7 200	15 800
	16.0	52' 6"	38.13	6 500	6 350	13 900	6 050	13 300
17.5	57' 5"	30.00	5 600	5 600	12 300	5 400	11 900	
22.0 (72'2")	5.1	16' 11"	79.51	30 200	30 200	66 500	28 500	62 800
	5.5	18' 1"	78.58	27 300	27 300	60 100	25 800	56 800
	6.0	19' 8"	77.25	24 200	24 050	53 000	22 650	49 900
	7.0	23' 0"	74.55	19 200	19 200	42 300	18 150	40 000
	8.0	26' 3"	71.82	15 900	15 900	35 000	15 050	33 100
	9.0	29' 6"	69.05	13 500	13 500	29 700	12 850	28 300
	10.0	32' 10"	66.22	11 800	11 750	25 900	11 150	24 500
	12.0	39' 4"	60.35	9 300	9 200	20 200	8 750	19 200
	14.0	45' 11"	54.11	7 600	7 450	16 400	7 100	15 600
	16.0	52' 6"	47.31	6 400	6 200	13 600	5 950	13 100
	18.0	59' 1"	39.64	5 500	5 300	11 600	5 100	11 200
20.0	65' 7"	30.41	4 700	4 600	10 100	4 400	9 700	
25.0 (82'0")	5.7	18' 8"	79.50	26 400	25 900	57 100	24 400	53 700
	6.0	19' 8"	78.80	24 100	24 000	52 900	22 650	49 900
	7.0	23' 0"	76.45	19 100	19 100	42 100	18 100	39 900
	8.0	26' 3"	74.07	15 700	15 700	34 600	15 000	33 000
	9.0	29' 6"	71.67	13 400	13 400	29 500	12 800	28 200
	10.0	32' 10"	69.23	11 700	11 700	25 700	11 100	24 400
	12.0	39' 4"	64.21	9 150	9 100	20 000	8 650	19 000
	14.0	45' 11"	58.97	7 500	7 400	16 300	7 050	15 500
	16.0	52' 6"	53.42	6 300	6 150	13 500	5 900	13 000
	18.0	59' 1"	47.42	5 400	5 200	11 400	5 000	11 000
	20.0	65' 7"	40.76	4 700	4 500	9 920	4 350	9 590
	22.0	72' 2"	33.01	4 100	3 900	8 590	3 800	8 370
22.7	74' 6"	30.00	3 900	3 750	8 260	3 650	8 040	
28.0 (91'10")	6.2	20' 4"	79.60	22 800	22 700	50 000	21 450	47 200
	7.0	23' 0"	77.93	19 000	19 000	41 800	18 000	39 600
	8.0	26' 3"	75.82	15 500	15 500	34 100	14 950	32 900
	9.0	29' 6"	73.70	13 300	13 300	29 300	12 700	27 900
	10.0	32' 10"	71.55	11 600	11 600	25 500	11 000	24 200
	12.0	39' 4"	67.16	9 050	9 000	19 800	8 550	18 800
	14.0	45' 11"	62.62	7 400	7 250	15 900	6 950	15 300
	16.0	52' 6"	57.88	6 200	6 050	13 300	5 800	12 700
	18.0	59' 1"	52.87	5 300	5 100	11 200	4 900	10 800
	20.0	65' 7"	47.50	4 600	4 350	9 590	4 250	9 360
	22.0	72' 2"	41.61	4 000	3 800	8 370	3 700	8 150
	24.0	78' 9"	34.93	3 500	3 300	7 270	3 250	7 160
	25.3	83' 0"	30.00	3 200	3 050	6 720	3 000	6 610

Boom length	Working radius		Boom angle	Rated load				
				JIS rating	BS rating		PCSA rating	
	m (ft in)	m	ft in	degree	kg	kg	lb	kg
31.0 (101'9")	7.0	23' 0"	79.11	18 900	18 900	41 600	18 000	39 600
	8.0	26' 3"	77.22	15 400	15 400	33 900	14 900	32 800
	9.0	29' 6"	75.32	13 200	13 200	29 100	12 650	27 800
	10.0	32' 10"	73.39	11 500	11 500	25 300	10 950	24 100
	12.0	39' 4"	69.48	8 900	8 900	19 600	8 550	18 800
	14.0	45' 11"	65.47	7 300	7 200	15 800	6 900	15 200
	16.0	52' 6"	61.31	6 100	5 950	13 100	5 750	12 600
	18.0	59' 1"	56.99	5 200	5 050	11 100	4 850	10 600
	20.0	65' 7"	52.43	4 500	4 300	9 470	4 150	9 140
	22.0	72' 2"	47.57	3 900	3 700	8 150	3 600	7 930
	24.0	78' 9"	42.29	3 400	3 250	7 160	3 200	7 050
	26.0	85' 4"	36.40	3 000	2 850	6 280	2 800	6 170
	27.9	91' 6"	30.00	2 550	2 550	5 620	2 500	5 510
34.0 (111'7")	8.0	26' 3"	78.37	15 300	15 300	33 700	14 850	32 700
	9.0	29' 6"	76.64	13 100	13 100	28 800	12 600	27 700
	10.0	32' 10"	74.90	11 400	11 400	25 100	10 900	24 000
	12.0	39' 4"	71.37	8 800	8 800	19 400	8 500	18 700
	14.0	45' 11"	67.76	7 200	7 150	15 700	6 850	15 100
	16.0	52' 6"	64.05	6 000	5 900	13 000	5 700	12 500
	18.0	59' 1"	60.23	5 100	4 950	10 900	4 800	10 500
	20.0	65' 7"	56.24	4 400	4 200	9 250	4 100	9 030
	22.0	72' 2"	52.06	3 800	3 650	8 040	3 550	7 820
	24.0	78' 9"	47.62	3 300	3 150	6 940	3 100	6 830
	26.0	85' 4"	42.84	2 900	2 750	6 060	2 750	6 060
	28.0	91' 10"	37.57	2 600	2 400	5 290	2 400	5 290
	30.0	98' 5"	31.57	2 300	2 150	4 730	2 150	4 730
30.5	100' 1"	30.00	2 250	2 100	4 620	2 100	4 620	
37.0 (121'5")	8.0	26' 3"	79.32	15 300	15 300	33 700	14 800	32 600
	9.0	29' 6"	77.74	13 000	13 000	28 600	12 550	27 600
	10.0	32' 10"	76.15	11 300	11 400	25 100	10 800	23 800
	12.0	39' 4"	72.93	8 800	8 800	19 400	8 400	18 500
	14.0	45' 11"	69.65	7 200	7 050	15 500	6 750	14 800
	16.0	52' 6"	66.30	6 000	5 800	12 700	5 600	12 300
	18.0	59' 1"	62.86	5 100	4 850	10 600	4 700	10 300
	20.0	65' 7"	59.31	4 400	4 150	9 140	4 050	8 920
	22.0	72' 2"	55.62	3 800	3 550	7 820	3 450	7 600
	24.0	78' 9"	51.76	3 300	3 050	6 720	3 000	6 610
	26.0	85' 4"	47.67	2 850	2 650	5 840	2 650	5 840
	28.0	91' 10"	43.30	2 500	2 300	5 070	2 350	5 180
	30.0	98' 5"	38.53	2 250	2 050	4 510	2 050	4 510
	32.0	105' 0"	33.19	1 900	1 800	3 960	1 850	4 070
33.0	108' 3"	30.00	1 750	1 650	3 630	1 700	3 740	

Continued on next page. ➔

Boom length	Working radius		Boom angle	Rated load				
				JIS rating	BS rating		PCSA rating	
				m (ft in)	m	ft in	degree	kg
40.0 (131'3")	9.0	29' 6"	78.67	12 900	12 900	28 400	12 450	27 400
	10.0	32' 10"	77.21	11 200	11 300	24 900	10 750	23 600
	12.0	39' 4"	74.25	8 750	8 700	19 100	8 300	18 200
	14.0	45' 11"	71.24	7 100	6 950	15 300	6 700	14 700
	16.0	52' 6"	68.18	5 900	5 700	12 500	5 500	12 100
	18.0	59' 1"	65.05	5 000	4 750	10 400	4 600	10 100
	20.0	65' 7"	61.84	4 300	4 000	8 810	3 950	8 700
	22.0	72' 2"	58.52	3 700	3 450	7 600	3 400	7 490
	24.0	78' 9"	55.08	3 200	2 950	6 500	2 950	6 500
	26.0	85' 4"	51.49	2 750	2 550	5 620	2 550	5 620
	28.0	91' 10"	47.71	2 400	2 200	4 850	2 250	4 960
	30.0	98' 5"	43.68	2 150	1 900	4 180	1 950	4 290
	32.0	105' 0"	39.33	1 850	1 650	3 630	1 750	3 850
	34.0	111' 7"	34.52	1 600	1 450	3 190	1 550	3 410
43.0 (141'1")	9.0	29' 6"	79.48	12 800	11 600	25 500	12 350	27 200
	10.0	32' 10"	78.12	11 100	11 200	24 600	10 650	23 400
	12.0	39' 4"	75.37	8 700	8 600	18 900	8 250	18 100
	14.0	45' 11"	72.60	7 000	6 850	15 100	6 600	14 500
	16.0	52' 6"	69.77	5 800	5 600	12 300	5 400	11 900
	18.0	59' 1"	66.90	4 900	4 650	10 200	4 550	10 000
	20.0	65' 7"	63.96	4 200	3 900	8 590	3 850	8 480
	22.0	72' 2"	60.95	3 600	3 350	7 380	3 300	7 270
	24.0	78' 9"	57.84	3 100	2 850	6 280	2 850	6 280
	26.0	85' 4"	54.62	2 700	2 450	5 400	2 450	5 400
	28.0	91' 10"	51.27	2 350	2 100	4 620	2 150	4 730
	30.0	98' 5"	47.74	2 050	1 800	3 960	1 850	4 070
	32.0	105' 0"	44.01	1 750	1 550	3 410	1 650	3 630
	34.0	111' 7"	40.00	1 500	1 350	2 970	1 450	3 190
46.0 (150'11")	10.0	32' 10"	78.90	11 000	9 700	21 300	10 650	23 400
	12.0	39' 4"	76.35	8 550	8 550	18 800	8 200	18 000
	14.0	45' 11"	73.77	6 900	6 800	14 900	6 550	14 400
	16.0	52' 6"	71.15	5 700	5 550	12 200	5 400	11 900
	18.0	59' 1"	68.49	4 800	4 600	10 100	4 500	9 920
	20.0	65' 7"	65.78	4 100	3 850	8 480	3 800	8 370
	22.0	72' 2"	63.01	3 500	3 300	7 270	3 250	7 160
	24.0	78' 9"	60.17	3 000	2 800	6 170	2 800	6 170
	26.0	85' 4"	57.24	2 500	2 400	5 290	2 400	5 290
	28.0	91' 10"	54.22	2 200	2 050	4 510	2 100	4 620
	30.0	98' 5"	51.07	1 900	1 750	3 850	1 800	3 960
	32.0	105' 0"	47.77	1 600	1 500	3 300	1 600	3 520
	34.0	111' 7"	44.29	1 300	1 300	2 860	1 400	3 080
	49.0 (160'9")	10.1	33' 2"	79.47	10 750	8 320	18 300	10 450
12.0		39' 4"	77.20	8 400	7 750	17 000	8 150	17 900
14.0		45' 11"	74.79	6 800	6 750	14 800	6 500	14 300
16.0		52' 6"	72.34	5 600	5 450	12 000	5 300	11 600
18.0		59' 1"	69.87	4 700	4 500	9 920	4 450	9 810
20.0		65' 7"	67.35	4 000	3 800	8 370	3 750	8 260
22.0		72' 2"	64.79	3 400	3 200	7 050	3 200	7 050
24.0		78' 9"	62.17	2 900	2 700	5 950	2 700	5 950
26.0		85' 4"	59.48	2 400	2 300	5 070	2 350	5 180
28.0		91' 10"	56.72	2 100	1 950	4 290	2 000	4 400
30.0		98' 5"	53.86	1 800	1 650	3 630	1 750	3 850
32.0		105' 0"	50.90	1 500	1 400	3 080	1 500	3 300
34.0		111' 7"	47.80	1 200	1 200	2 640	1 300	2 860

Boom length	Working radius		Boom angle	Rated load				
				JIS rating	BS rating		PCSA rating	
	m (ft in)	m	ft in	degree	kg	kg	lb	kg
52.0 (170'7")	12.0	39' 4"	77.95	8 200	6 650	14 600	8 050	17 700
	14.0	45' 11"	75.68	6 700	6 200	13 600	6 400	14 100
	16.0	52' 6"	73.39	5 500	5 350	11 700	5 250	11 500
	18.0	59' 1"	71.08	4 600	4 400	9 700	4 350	9 590
	20.0	65' 7"	68.73	3 900	3 700	8 150	3 650	8 040
	22.0	72' 2"	66.34	3 300	3 100	6 830	3 100	6 830
	24.0	78' 9"	63.90	2 800	2 600	5 730	2 650	5 840
	26.0	85' 4"	61.41	2 350	2 200	4 850	2 250	4 960
	28.0	91' 10"	58.87	2 000	1 850	4 070	1 950	4 290
	30.0	98' 5"	56.25	1 700	1 550	3 410	1 650	3 630
	32.0	105' 0"	53.54	1 400	1 300	2 860	1 400	3 080
34.0	111' 7"	50.74	1 100	1 050	2 310	1 200	2 640	

Rated Load for Main Boom

- Notes: 1) The rated loads shown are based on the machine on firm level ground without traveling.
 2) The rated loads shown include the weights of all lifting attachments, such as hook and bucket. The load to be actually lifted is the rated load minus the weight of all lifting attachments.
 3) When the jib or the auxiliary jib is attached, the load to be actually lifted is the rated load minus the weight listed below.

Jib length	6.10 m (20'0")	9.15 m (30'0")	12.20 m (40'0")	15.25 m (50'0")	Aux. jib
Weight to be reduced	700 kg (1 540 lb)	850 kg (1 870 lb)	1 000 kg (2 200 lb)	1 150 kg (2 540 lb)	200 kg (440 lb)

- 4) The jib can be attached to boom of 22.0 m (72'2") to 43.0 m (141'0") long.
 5) The auxiliary jib can be attached to boom of 13.0 m (42'8") to 49.0 m (160'8") long.
 6) The rated load for auxiliary jib is equal to that of main boom at the same working radius, but do not exceed maximum rated load 5 000 kg (11 100 lb).
 7) Counterweight is 15 900 kg (35 100 lb).
 8) In operation, crawlers must be extended.

Rated Load for Jib

Maximum jib rating

Jib length		6.10 m (20'0")	9.15 m (30'0")	12.20 m (40'0")	15.25 m (50'0")
Jib offset angle					
Max. rated load	10°	5 000 kg (11 020 lb)	5 000 kg (11 020 lb)	4 000 kg (8 820 lb)	3 250 kg (7 170 lb)
	30°	5 000 kg (11 020 lb)	4 600 kg (10 140 lb)	3 650 kg (8 050 lb)	3 050 kg (6 720 lb)

- Notes: 1) The rated load for jib is equal to that of the main boom at the same working radius, but should not exceed maximum jib ratings shown. The jib offset angle to the main boom is 10° and 30° under loaded condition.
 2) The maximum working radius of the jib do not exceed that of the main boom used.

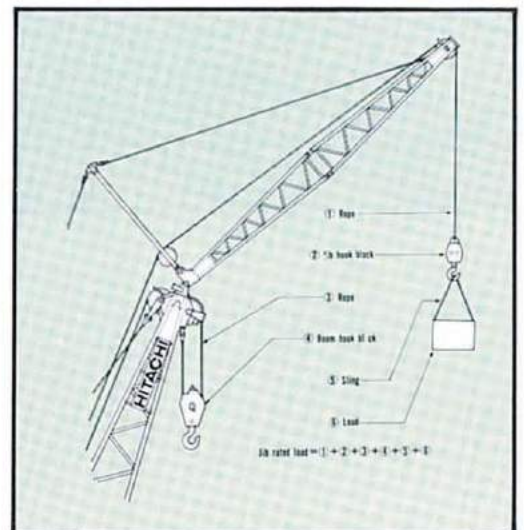
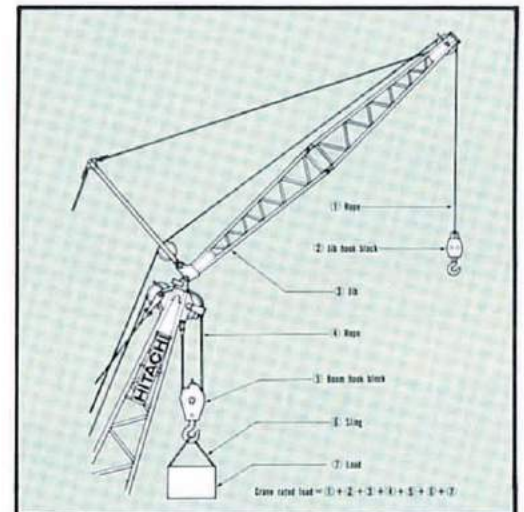

Boom & Jib Construction

Main Boom Construction

Element \ Boom length	13.0 m (42'8")	16.0 m (52'6")	19.0 m (62'4")	22.0 m (72'2")	25.0 m (82'0")	28.0 m (91'10")	31.0 m (101'8")	34.0 m (111'7")	37.0 m (121'5")	40.0 m (131'3")	43.0 m (141'0")	46.0 m (150'11")	49.0 m (160'9")	52.0 m (170'7")																						
Upper Boom 6.5 m (21'4")	1	1	1	1	1	1	1	1	1	1	1	1	1	1																						
Lower Boom 6.5 m (21'4")	1	1	1	1	1	1	1	1	1	1	1	1	1	1																						
3.0 m (9'10") Boom insert	-	1	2	-	1	-	2	-	1	1	-	2	-	1	2	-	1	-	1																	
6.0 m (19'8") Boom insert	-	-	-	1	1	-	1	2	-	2	1	-	1	2	3	3	1	2	2	3	1	4	3	1	4	3	2	5	4	2	5	4	3	6	5	3
9.0 m (29'6") Boom insert	-	-	-	-	1	-	-	1	-	1	1	-	-	1	1	1	-	2	-	1	2	-	1	2	-	1	2	-	1	2	-	1	2	-	1	2
Available hook	50 000 kg (110 200 lb) hook				30 000 kg (66 100 lb) hook				15 000 kg (33 100 lb) hook																											
Number of rope reeving	9	9	7	6	5	5	4	3	3	3	3	2	2	2																						
Boom available with jib																																				
Boom available with Auxiliary jib																																				

For the boom construction corresponding to the column , the boom length can not always be realized at a 3 m pitch.

Jib Construction

Element \ Jib length	6.10 m (20'0")	9.15 m (30'0")	12.20 m (40'0")	15.25 m (50'0")	
Lower Jib	3.05 m (10'0")	1	1	1	1
Upper Jib	3.05 m (10'0")	1	1	1	1
Jib Insert	3.05 m (10'0")	-	1	2	3
Available hook	5 000 kg (11 000 lb) hook				

Auxiliary Jib (Optional)

Attachable to main boom top for hoisting light-weight load quickly with a single rope used. (Never use the main and auxiliary hooks at the same time.)

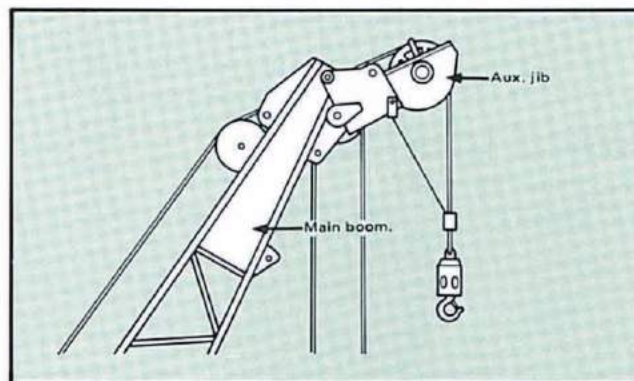



TOWER CRANE

With Tubular Chord TOWER Boom

Working Ranges

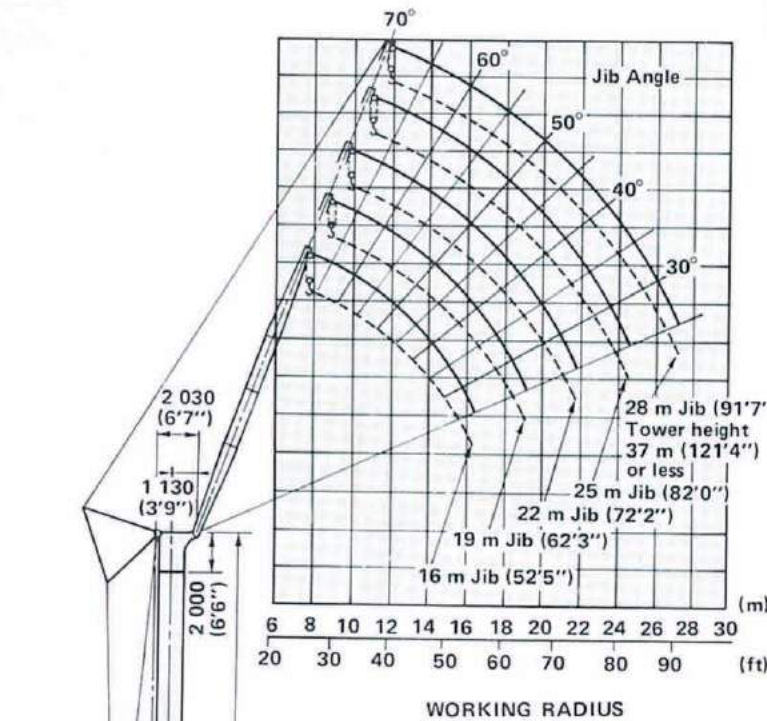

Lifting Height Above Ground

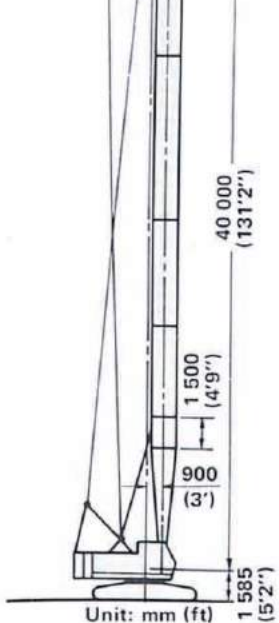
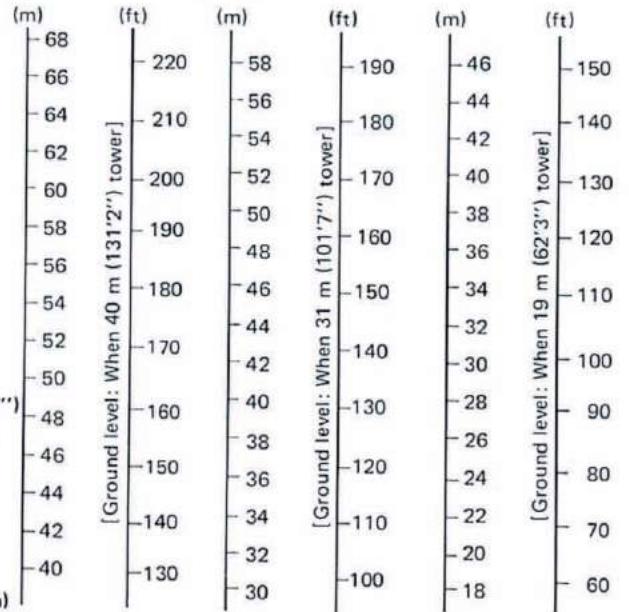

Unit: mm (ft) 1 585 (5'2")

Specifications

Maximum rated load	11 400 kg at 10.3 m (25 000 lb at 37'4")
Tower boom length	19.0 m (62'3") to 40.0 m (131'2")
Jib length	16.0 m (52'6") to 28.0 m (91'9")
Max. tower boom + Jib boom	65.0 m (213'3") [40.0 m (131'2") + 25.0 m (82'0")]
Tower boom point maximum height above ground	41.6 m (136'5")
Working radius	8.5 m (27'9") to 27.5 m (90'2")
Maximum lifting height above ground	63.0 m (206'7")
Ground pressure	0.68 bar (0.69 kgf/cm ² 9.8 psi)
Operating weight [40.0 m (131'2") tower boom plus 25.0 m (82'0") jib]	52 400 kg (115 500 lb)

Note: For common specifications which are not listed above, refer to P.4 and P.5.

Rated Load Curves

78% of tipping load (JIS)

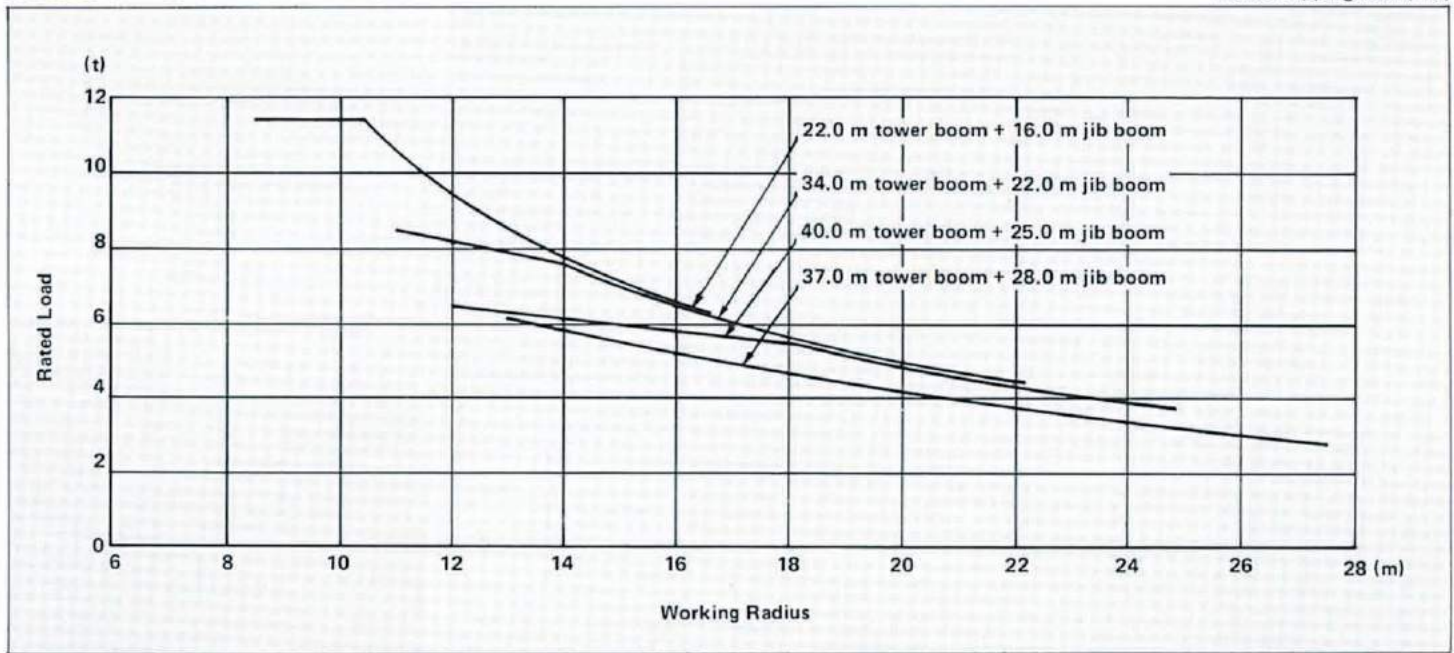

Rated Loads

78% of tipping load (JIS)

Tower length Jib length Working radius	19.0 m, 22.0 m			25.0 m, 28.0 m			31.0 m, 34.0 m					37.0 m, 40.0 m				37.0 m	
	16.0 m	19.0 m	16.0 m	19.0 m	22.0 m	25.0 m	16.0 m	19.0 m	22.0 m	25.0 m	28.0 m	16.0 m	19.0 m	22.0 m	25.0 m	28.0 m	
8.0 m	8.5m x 11.4tonne																
9.0 m	11.4tonne	9.5m x 11.25tonne	11.4tonne				10.40tonne					8.60tonne					
10.0 m	10.3m x 11.4tonne	10.90tonne	9.5m x 11.4tonne	10.5tonne	11.0m x 9.40tonne		10.00tonne	9.35tonne	11.0m x 8.40tonne			8.40tonne	7.80tonne	11.0m x 7.10tonne			
12.0 m	9.40tonne	11.1m x 10.3tonne	10.7m x 10.9tonne	11.6m x 9.75tonne	9.00tonne	8.20tonne	11.95m x 9.45tonne	8.70tonne	8.10tonne	7.55tonne	13.0m x 6.15tonne	8.05tonne	7.45tonne	6.90tonne	6.45tonne	13.0m x 6.15tonne	
14.0 m	7.75tonne	7.70tonne	7.75tonne	7.70tonne	12.5m x 8.80tonne	7.30tonne	7.75tonne	13.1m x 8.35tonne	14.2m x 7.55tonne	7.05tonne	5.75tonne	7.75tonne	15.2m x 6.95tonne	6.50tonne	6.10tonne	5.75tonne	
16.0 m	6.60tonne	6.55tonne	6.60tonne	6.55tonne	6.50tonne	15.5m x 6.70tonne	6.60tonne	6.55tonne	6.50tonne	15.5m x 6.70tonne	5.15tonne	6.60tonne	6.55tonne	16.7m x 5.50tonne	5.75tonne	5.15tonne	
18.0 m	16.6m x 6.30tonne	5.65tonne	16.6m x 6.30tonne	5.65tonne	5.60tonne	5.55tonne	16.6m x 6.30tonne	5.65tonne	5.60tonne	5.55tonne	4.65tonne	16.6m x 6.30tonne	5.65tonne	5.60tonne	18.2m x 5.50tonne	4.65tonne	
20.0 m		19.3m x 5.20tonne		19.3m x 5.20tonne	4.95tonne	4.90tonne		19.3m x 5.20tonne	4.95tonne	4.90tonne	4.15tonne		19.3m x 5.20tonne	4.95tonne	4.90tonne	4.15tonne	
22.0 m					4.40tonne	4.35tonne			4.40tonne	4.35tonne	3.75tonne			4.40tonne	4.35tonne	3.75tonne	
24.0 m					22.1m x 4.38tonne	3.90tonne			22.1m x 4.38tonne	3.90tonne	3.35tonne			22.1m x 4.38tonne	3.90tonne	3.35tonne	
26.0 m						24.8m x 3.70tonne				24.8m x 3.70tonne	3.00tonne				24.8m x 3.70tonne	3.00tonne	
28.0 m											27.5m x 2.70tonne					27.5m x 2.70tonne	

- Notes:
- The rated total loads given in the table above are values taken at the time when the load is to be lifted with the machine placed on a flat, firm ground, not exceeding 78% of tipping loads and with the forward stability of 1.15 or more as specified in the Travelling Crane Construction Standards.
 - The load to be actually lifted will be the value of each rated total load given in the table above minus total weight of all lifting means such as hook.
 - Hook weight: 15-tonne capacity hook (for tower crane) 0.4 tonne.

Tower Crane Boom & Jib Construction

Tower Boom Construction

Tower boom length Element	19.0m (62'4")	22.0m (72'2")	25.0m (82'0")	28.0m (91'10")	31.0m (101'9")	34.0m (111'7")	37.0m (121'5")	40.0m (131'3")
Lower tower 6.5m (21'4")	1	1	1	1	1	1	1	1
Upper tower 2.0m (6'6")	1	1	1	1	1	1	1	1
Insert 1.5m (4'11")	1	1	1	1	1	1	1	1
Insert 3.0m (9'10")	—	1	2	1	2	1	2	1
Insert 6.0m (19'8")	—	—	—	1	1	2	2	3
Insert 9.0m (29'6")	1	1	1	1	1	1	1	1
Available jib	<p>Jib length 16.0m (52'6")</p> <p>Jib length 19.0m (62'4")</p> <p>Jib length 22.0m (72'2")</p> <p>Jib length 25.0m (82'0")</p> <p>Jib length 28.0m (91'9")</p>							



Jib Construction

Jib boom length Element	16.0m (52'6")	19.0m (62'4")	22.0m (72'2")	25.0m (82'0")	28.0m (91'10")
Jib: lower 5.0m (16'5")	1	1	1	1	1
Jib: upper 5.0m (16'5")	1	1	1	1	1
3.0m (9'10") Jib insert	2	1	2	1	2
6.0m (19'8") Jib insert	—	1	1	2	2



CLAMSHELL

With Tubular CRANE Boom

Dimensions

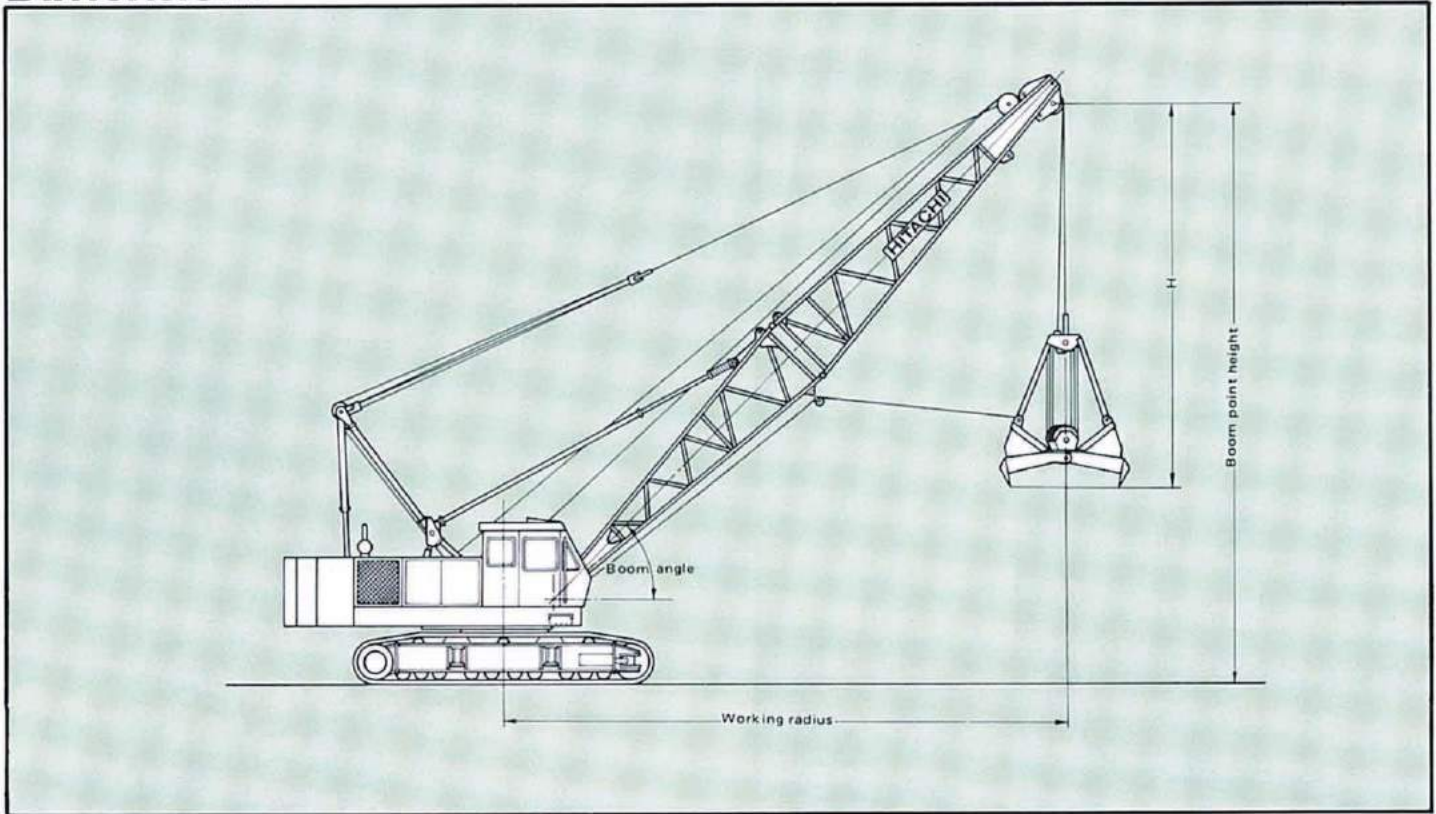

Specifications

Bucket capacity	0.6 m ³ (0.78 cu yd), 0.8 m ³ (1.05 cu yd), 1.0 m ³ (1.31 cu yd), 1.2 m ³ (1.57 cu yd)
Boom length	13.0 m (42'8"), 16.0 m (52'6"), 19.0 m (62'4")
Gradeability	22° (40%)
Ground pressure	0.64 bar (0.64 kgf/cm ² , 9.10 psi)
Operating weight	48 400 kg (106 700 lb) When equipped with 13.0 m (42'8") boom, 1.0 m ³ (1.31 cu yd) bucket and 15 900 kg (35 100 lb) counterweight

Note: For common specifications which are not listed above, refer to p. 4 and p. 5.

BUCKETS

Capacity	Self weight	Bucket clearance : H
0.6 m ³ (0.78 cu yd)	1 600 kg (3 530 lb)	5.1 m (16'9")
0.8 m ³ (1.05 cu yd)	2 000 kg (4 410 lb)	5.4 m (17'9")
1.0 m ³ (1.31 cu yd)	2 450 kg (5 400 lb)	5.7 m (18'8")
* 1.2 m ³ (1.57 cu yd)	2 400 kg (5 290 lb)	5.7 m (18'8")

* 1.2 m³ (1.57 cu yd) bucket is light-duty service.

TAGLINE

	Maximum digging depth
Hydraulic operated type	36.0 m (118'1")

Clamshell Ratings and Working Ranges

Boom length	Working radius		Boom angle	Boom point height		Rated loads								
						JIS rating	BS rating (1)		BS rating (2)		PCSA rating (1)		PCSA rating (2)	
						m (ft in)	m	ft in	degree	m	ft in	kg	kg	lb
13.0 (42'8")	6.7	22'0"	65	13.3	43'8"	5 000	6 000	13 230	5 000	11 020	6 000	13 230	5 000	11 020
	8.7	28'7"	55	12.1	39'8"	5 000	6 000	13 230	5 000	11 020	6 000	13 230	5 000	11 020
	10.4	34'2"	45	10.6	34'9"	5 000	6 000	13 230	5 000	11 020	6 000	13 230	5 000	11 020
	11.8	38'9"	35	8.9	29'2"	5 000	6 000	13 230	5 000	11 020	6 000	13 230	5 000	11 020
16.0 (52'6")	8.0	26'3"	65	16.0	52'6"	5 000	6 000	13 230	5 000	11 020	6 000	13 230	5 000	11 020
	10.4	34'2"	55	14.6	47'11"	5 000	6 000	13 230	5 000	11 020	6 000	13 230	5 000	11 020
	12.6	41'5"	45	12.7	41'8"	5 000	6 000	13 230	5 000	11 020	6 000	13 230	5 000	11 020
	14.3	46'11"	35	10.6	34'9"	5 000	5 900	13 010	5 000	11 020	6 000	13 230	5 000	11 020
19.0 (62'4")	9.3	30'6"	65	18.7	61'4"	5 000	6 000	13 230	5 000	11 020	6 000	13 230	5 000	11 020
	12.2	40'1"	55	17.0	55'9"	5 000	6 000	13 230	5 000	11 020	6 000	13 230	5 000	11 020
	14.7	48'3"	45	14.9	48'11"	5 000	5 650	12 460	5 000	11 020	6 000	13 230	5 000	11 020
	16.8	55'2"	35	12.3	40'4"	5 000	4 750	10 470	4 750	10 470	5 100	11 240	5 000	11 020

- Notes:
- 1) The rated loads shown include the bucket weight. The load to be actually lifted is the rated load minus bucket weight.
 - 2) The BS (1) and PCSA (1) rated loads shall apply to the power load lowering operation, or free fall operation in the case when buckets self weight are less than 2 500 kg (5 510 lb).
 - 3) The BS (2) and PCSA (2) rated loads shall apply to the free fall operation where buckets self weight are over 2 500 kg (5 510 lb).

- 4) In operation, crawlers must be extended.
- 5) Counterweight is 15 900 kg (35 100 lb).
- 6) Permissible boom length for clamshell operation is 13 m (42'8") to 19 m (62'4").
- 7) The bucket supporting/operating rope length varies with the boom length and excavation depth.
- 8) For bucket fall operation, please use the power fall and free fall by half-braking (The standard free fall stroke is preferably to be set at 10 m (32'10") or less.) in combination.

DRAGLINE

Angle Chord DUTY CYCLE Boom

Dimensions

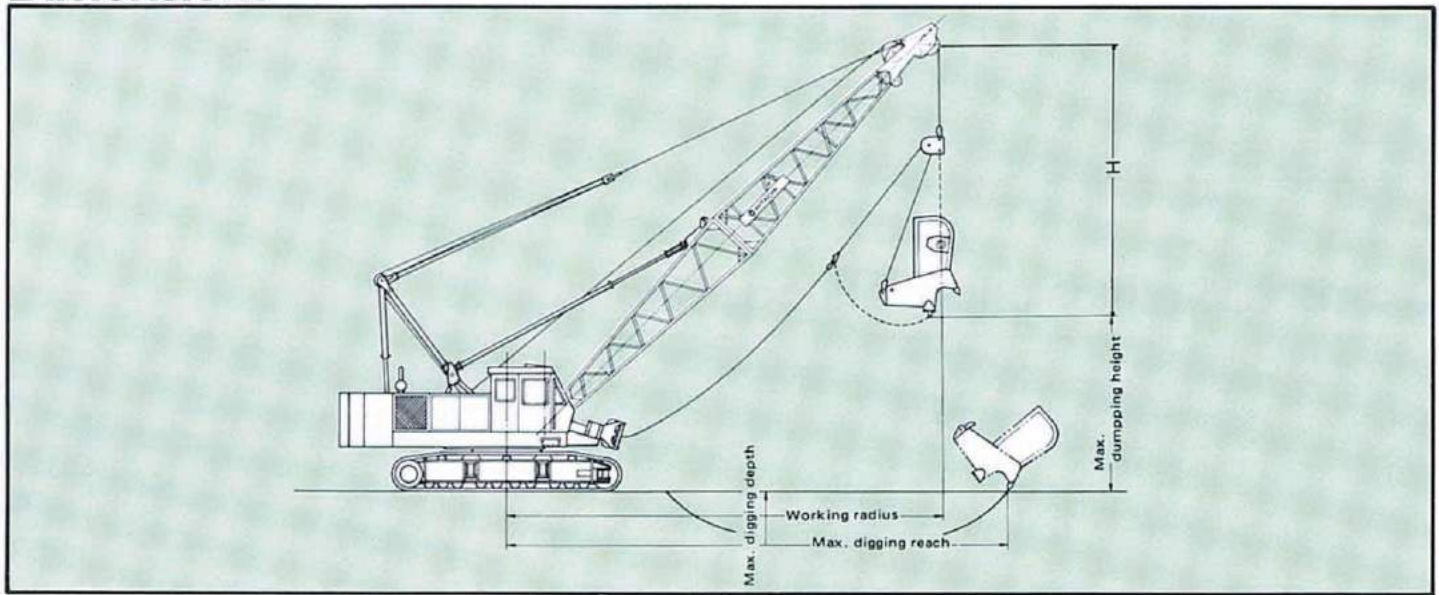

Specifications

Bucket capacity	0.8 m ³ (1.05 cu yd) — 1.0 m ³ (1.31 cu yd)
Boom length	13 m (42'8") — 19 m (62'4")
Gradeability	22° (40%)
Operating weight with 19 m (62'4") boom	48 700 kg (107 400 lb) with 0.8 m ³ (1.05 cu yd) bucket
Ground pressure	0.65 bar (0.65 kgf/cm ² , 9.24 psi)

Note: For common specification which are not listed above, refer to P.4 and P.5.

Buckets

Capacity	Self weight	Bucket Clearance : H	Application
0.8 m ³ (1.05 cu yd)	1 200 kg (2 650 lb)	4.0 m (13'1")	Heavy-duty
1.0 m ³ (1.31 cu yd)	1 600 kg (3 530 lb)	4.2 m (13'9")	Medium-duty

Dragline Ratings and Working Ranges

Boom length	Working radius		Boom angle	Max. dumping height		Max. digging reach		Max. digging depth		Rated load				
										JIS rating	BS rating		PCSA rating	
m (ft in)	m	ft in	degree	m	ft in	m	ft in	m	ft in	kg	kg	lb	kg	lb
13.0 (42'8")	12.5	41'0"	30	3.0	9'10"	16.1	52'10"	9.1	29'10"	3 300	3 300	7 280	3 300	7 280
	11.2	36'9"	40	4.8	15'9"	15.6	51'2"	8.8	28'10"	3 300	3 300	7 280	3 300	7 280
	9.7	31'10"	50	6.5	21'4"	14.8	48'7"	8.2	26'11"	3 300	3 300	7 280	3 300	7 280
16.0 (52'6")	15.1	49'6"	30	4.5	14'9"	19.3	63'4"	11.5	37'9"	3 300	3 300	7 280	3 300	7 280
	13.5	44'3"	40	6.8	22'4"	18.8	61'8"	11.2	36'9"	3 300	3 300	7 280	3 300	7 280
	11.6	38'1"	50	8.8	28'10"	17.8	58'5"	10.4	34'1"	3 300	3 300	7 280	3 300	7 280
19.0 (62'4")	17.7	58'1"	30	6.0	19'8"	22.6	74'2"	14.0	45'11"	3 300	3 300	7 280	3 300	7 280
	15.8	51'10"	40	8.7	28'7"	21.2	69'7"	13.0	42'8"	3 300	3 300	7 280	3 300	7 280
	13.5	44'3"	50	11.1	36'5"	20.7	67'11"	12.6	41'4"	3 300	3 300	7 280	3 300	7 280

- Notes: 1) The rated loads shown include the bucket weight. The load to be actually lifted is the rated load minus bucket weight.
2) Maximum digging reach/depth may vary considerably depending on digging condition and the skill

- of the operator.
3) In operation, crawlers must be extended.
4) Counterweight is 15 900 kg (35 100 lb).
5) Permissible boom length for dragline operation is 13 m (42'8") to 19 m (62'4").

DRUMS

Dimensions

	Rope dia.	Width	Drum p.c.d.	Max. rope capacity
Main hoist drum	22 mm (0.866")	360 mm (14.17")	462 mm (18.19")	224 m (735')
Aux. hoist drum	22 mm (0.866")	313 mm (12.32")	462 mm (18.19")	194 m (636')

(9th layer)

Line speed and line pull

	Max. line speed m/min (ft/min)				Effective line pull	@	Line speed	Max. starting line pull	Max. running line pull
	Hoisting		Lowering						
Main hoist drum	H	70 (230)	H	70 (230)	108 kN (11 000 kgf) (24 300 lbf)	@	34 m/min (112 ft/min)	140 kN (14 300 kgf) (31 600 lbf)	153 kN (15 600 kgf) (34 400 lbf)
	L	35 (115)	L	35 (115)					
Aux. hoist drum	H	70 (230)	H	70 (230)	108 kN (11 000 kgf) (24 300 lbf)	@	34 m/min (112 ft/min)	140 kN (14 300 kgf) (31 600 lbf)	153 kN (15 600 kgf) (34 400 lbf)
	L	35 (115)	L	35 (115)					

H: High speed range L: Low speed range

- Notes: 1) Line speed and line pull are based on first layer of winding at rated engine rpm.
2) Hoisting line speed varies with load.
3) Line pull is based on a single line pull in high speed range.
4) Effective line pull is equivalent to available line pull of mechanical drive winch.
5) When starting, hydraulic motor is without rotating, the line pull is "Max. starting line pull". After motor rotating, the line pull becomes "Max. running line pull" shortly.
6) Main and auxiliary hoist drums have spiral rope grooves.

BOOM HOIST DRUM

Rope diameter	Hoisting line speed	Lowering line speed
16 mm (0.63")	60 m/min (197 ft/min)	60 m/min (197 ft/min)

BOOM-SUPPORT TYPE PILE DRIVER

With Tubular CRANE
Boom

Dimensions

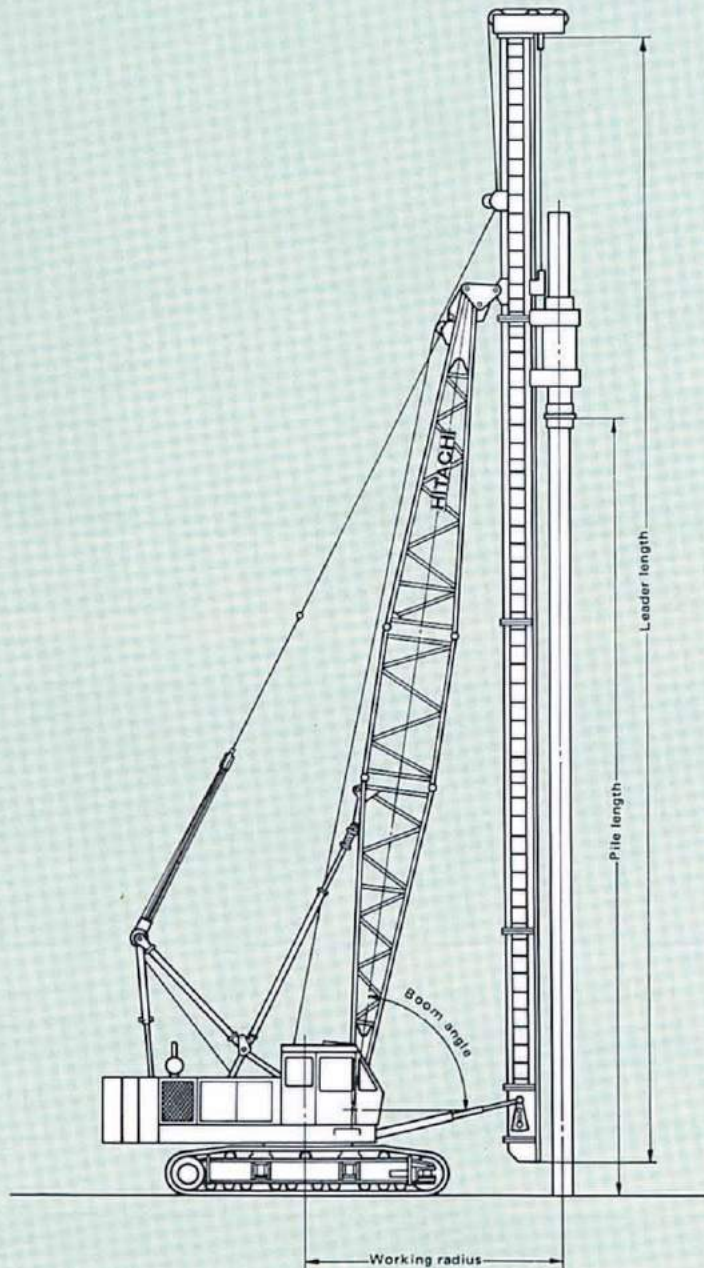

Specifications

Leader model	45 S							
Counterweight	15 900 kg (35 100 lb)							
Hammer	35				45			
Hammer weight	7 500 kg (16 500 lb)				10 500 kg (23 100 lb)			
Cap weight	1 000 kg (2 200 lb)				1 800 kg (3 970 lb)			
Boom length	16.0 m (52'6")		19.0 m (62'4")		16.0 m (52'6")		19.0 m (62'4")	
Leader length	22.0 m (72'2")		25.0 m (82'0")		22.0 m (72'2")		25.0 m (82'0")	
Pile length	14.0 m (45'11")		17.0 m (55'9")		14.0 m (45'11")		17.0 m (55'9")	
R: Working radius W: Rated load	R	W	R	W	R	W	R	W
Boom angle (degree)	82°	4.9 m (16'1") 7 000 kg (15 400 lb)	5.3 m (17'5") 7 000 kg (15 400 lb)	5.0 m (16'5") 7 000 kg (15 400 lb)	5.4 m (17'9") 7 000 kg (15 400 lb)	5.8 m (19'0") 5 700 kg (12 600 lb)		
	81°	5.2 m (17'1") 7 000 kg (15 400 lb)	5.7 m (18'8") 7 000 kg (15 400 lb)	5.3 m (17'5") 7 000 kg (15 400 lb)	5.8 m (19'0") 5 700 kg (12 600 lb)			
	80°	5.5 m (18'1") 7 000 kg (15 400 lb)	6.0 m (19'8") 7 000 kg (15 400 lb)	5.6 m (18'4") 7 000 kg (15 400 lb)				
	79°	5.8 m (19'0") 7 000 kg (15 400 lb)		5.8 m (19'0") 7 000 kg (15 400 lb)				
	78°	6.0 m (19'8") 7 000 kg (15 400 lb)						
Operating weight	62 000 kg (136 700 lb)		62 900 kg (138 700 lb)		65 800 kg (145 100 lb)		66 700 kg (147 050 lb)	
Ground pressure	0.82 bar (0.82 kgf/cm ² , 11.6 psi)		0.83 bar (0.83 kgf/cm ² , 11.8 psi)		0.87 bar (0.87 kgf/cm ² , 12.3 psi)		0.88 bar (0.88 kgf/cm ² , 12.5 psi)	

Specifications



SUPERSTRUCTURE



Engine

Model	HINO EM100
Type	Water-cooled, 4-cycle, 6-cylinder, direct fuel injection type diesel engine. 175g/ps-hr
Rated horsepower	110 kW (150 PS) at 2 000 min ⁻¹ (2 000 rpm)
(DIN 6 270, Net)	
Maximum torque	588 N·m (60 kgf·m, 434 ft·lbf) at 1 600 min ⁻¹ (1 600 rpm)
Piston displacement	9.4 l (575 cu in)
Fuel tank capacity	250 l (55 Imp gal, 66 U.S. gal)
Electric system	24 V DC. AC generating



Main and Auxiliary Hoist Mechanism

Both main and auxiliary hoist drums are driven independently by swash plate type axial piston motors through reduction gear. Load hoisting/lowering are done by normal/reverse rotation of motor. Smooth, precise power lowering is made possible by the hydraulic brake. A single lever gives a choice of two speeds, high or low, for hoisting/lowering. Hoist/lower speeds are proportioned to the lever stroke, allowing easy matching to job conditions.

Option: One motor driven type winch for main and auxiliary drums is available.

Clutches Clutches are of the spring-set, hydraulic-released internal-expanding friction band type; main and auxiliary clutches are alike in size and type, with interchangeable clutch linings.

Brakes External contracting friction band-type mechanical brakes, integrated with link lever, operate under normal load. For a larger load, a spring-type boost device is provided to ensure fatigue-free operation. Mechanical brake locks are equipped as standard. Furthermore, while in neutral position the hoist lever is doubly secured in position by a hydraulic, brake and an automatic brake. An automatic brake system or hydraulic positive brake system, in neutral position of the hoist lever, can be selected according to job application.

Drums Main and auxiliary hoist drums are of special alloy cast iron. Both hoist drums are mounted on the lifetime-lubricated antifriction ball bearings.

Drum locks Drum pawl locks are provided for integral lock of drums. They are manually controllable from the operator's seat.



Boom Hoist Mechanism

Completely independent operation. Boom hoisting/lowering is done by normal/reverse rotation of the bent axis motor. Boom lowering is made by power lowering through the hydraulic system. Instant hoisting/lowering of boom is possible. Both hydraulic brake and spring-set hydraulic-released multiplate disc type brake offer positive and safe stopping of boom. When boom is hoisted or lowered, brakes are automatically released.

Boom Brakes Spring-set, hydraulic-released multiplate disc type. Brake is automatically actuated when control lever is at neutral position.

Drum Locks Drum pawl lock is manually controlled from operator's seat.



Swing Mechanism

Completely independent operation. Driven by high-torque piston motor through reduction gear, swing speeds are freely controllable within the 0 to maximum speed with single lever stroking.

Swing Brake A disc type swing brake can be hydraulically actuated by the brake switch on the swing lever.

Swing Lock Manually operated mechanical lock with a roc tip which is engaged in a holder of track frame during transportation.

Swing Circle Single-row shear-type ball bearing with heat treated internal gear.



Revolving Frame

All steel welded construction, stress-relieved, precision-machined unit, especially designed for rigidity and strength.

Gantry Lowerable for transportation.

Counterweight Welded structure. Total weight 15 900 kg (35 100 lb)

Consists of 2 sections: One: 7 500 kg (16 500 lb)
One: 8 400 kg (18 400 lb)



Boom

Tubular Chord CRANE Boom 1 300 mm (51") wide by, 1 300 mm (51") deep at connection, lattice construction, high tensile strength steel tubular chord.

Basic boom 2-piece, total length 13.0 m (42'8");
upper section 6.5 m (21'4") and lower
section 6.5 m (21'4").

Boom point	Offset boom point, 5 sheaves [420 mm (16.5") p.c.d.] mounted on anti-friction bearings on boom peak.
Boom insert	3.0 m (9'10"), 6.0 m (19'8") and 9.0 m (29'6") long available with appurtenant pendants.
Connection type	Pin-connected
Boom backstop	Dual-rail, telescopic tubular construction with spring bumper.
Boom hoist bridle	Serves as connection between pendants and boom hoist wire rope reeving, equipped with 6 sheaves [340 mm (13.4") p.c.d.] for 12-part boom hoist wire rope reeving.

Crane Jib 550 mm (22") wide by 480 mm (19") deep at connection, lattice construction, high tensile strength steel tubular chord.

Basic jib	2-piece, total length 6.10 m (20'0"), upper section 3.05 m (10'0"), and lower section 3.05 m (10'0").
Jib point	1 sheave [400 mm (15.7") p.c.d.] mounted on anti-friction bearings on jib peak.
Jib insert	3.05 m (10'0") long available.
Connection type	Pin-connected
Auxiliary jib	Optional Attachable to main boom top for hoisting lightweight load quickly with a single rope used.

Note: Boom insert, crane jib, or auxiliary jib can be attached to the basic boom when needed. However both, crane jib and auxiliary jib cannot be attached simultaneously to the boom and used.

Angle Chord DRAGLINE Boom 1 202 mm (47") wide by 1 102 mm (43") deep at connection, lattice construction, high tensile strength steel angle chord.

Basic boom	2-piece, total length 13.0 m (42'8"); upper section 6.5 m (21'4") and lower section 6.5 m (21'4").
Boom point	Offset boom point, single sheave [sheave p.c.d.; 530 mm (20.9")] mounted on anti-friction bearing on boom peak.
Boom insert	3.0 m (9'10") and 6.0 m (19'8") long available with appurtenant pendants.
Connection type	Bolt connected.
Boom backstop	Dual-rail, telescopic tubular construction with spring bumper.
Boom hoist bridle	Serves as connection between pendants and boom hoist wire rope reeving, equipped with 6 sheaves [300 mm (12") p.c.d.] for 12-part boom hoist wire rope reeving.

Tubular Chord TOWER CRANE Boom 1 300 mm (51") wide by 1 300 mm (51") deep at connection, lattice construction, high tensile strength steel tubular chord.

Tower boom length	Minimum: 19 m (62'3") Maximum: 40 m (131'2")
-----------------------------	---

Tower insert	3.0 m (9'10"), 6.0 m (19'8") and 9.0 m (29'6") tower insert are in common with each crane boom insert.
------------------------	--

Connection type	Pin-connected.
Tower backstop	Dual-rail, telescopic tubular construction with spring dumper.
Tower hoist bridle	Serves as connection between tower boom pendants and tower boom hoist wire rope reeving, equipped with 6 sheaves [340 mm (13.4") p.c.d.] mounted on anti-friction bearing.

Tower Jib

Jib	940 mm (37") wide by 750 mm (30") deep at connection, lattice construction, high tensile strength steel tubular chord.
Jib length	16.0 m (52'6") to 28.0 m (91'9")
Jib insert	3.0 m (9'10") and 6.0 m (19'8") long available.
Connection type	Pin-connected.



Operator's Cab

All-weather, well-ventilated, all-round visibility, roomy operator's cab. The completely independent cab is insulated against noise and vibration. Sliding, fold-in front window swings up and stores in roof. Fully adjustable reclining seat.



UNDERCARRIAGE

Traction mechanism Each track is driven by a bent axis motor through reduction gear. This mechanism allows counter-rotation of tracks for maximum maneuverability in close quarters. When lever is at neutral position, both hydraulic brake and spring-set/hydraulic-released multiplate disc brake are automatically actuated to effect reliable stopping. Upper and lower rollers, sprockets and idlers are lifetime-lubricated. A hydraulic track adjuster is provided for easy tension adjustment of each track.

Track Frame All-welded, stress relieved, box section construction.

Side Frame Side frames of all-welded construction can be retracted for transportation.

Side Frame Extending/Retracting Device Side frame extending/retracting is done with the cylinder provided inside the track frame. Hydraulic power source for this extending/retracting cylinder is common with that for the left track. All that's required is to operate the switching valve installed inside the track frame and shift the left travel lever. Then, side frame extending/retracting can easily be done in a short time eliminating troublesome piping, etc.

Track Link Disengaging Prevention Device Track link disengaging prevention device goes up and down together with the track link to prevent it from coming off.

Track Shoes Heat treated alloy steel castings with induction hardened roller path and driving lugs. Shoes are connected by induction-hardened steel pins.

No. of upper rollers (on each side) 3
 No. of lower rollers (on each side) 10
 No. of track shoes (on each side) 59
 Shoe width 760 mm (30")

HYDRAULIC SYSTEM

2 variable displacement piston pumps + 1 gear pump hydraulic system allows both independent and combined operations of all functions. Variable-displacement piston pumps not only adequately control operating speeds, but also utilize engine horsepower to maximum.

	Pump-1	Pump-2
Type of pump	Variable displacement pump	
Pressure setting	300 bar (300 kgf/cm ² , 4 270 psi)	300 bar (300 kgf/cm ² , 4 270 psi)
Oil flow	200 l/min (44.0 Imp gpm, 52.7 U.S. gpm)	200 l/min (44.0 Imp gpm, 52.7 U.S. gpm)

	Pump-3	Pump-4
Type of pump	Gear pump	
Pressure setting	210 bar (210 kgf/cm ² , 2 990 psi)	45 bar (45 kgf/cm ² , 640 psi)
Oil flow	134 l/min (29.5 Imp gpm, 35.0 U.S. gpm)	32 l/min (7.0 Imp gpm, 8.4 U.S. gpm)

Main and Auxiliary Hoist Motor (Common Motor)
 Swash plate type axial piston motor with counterbalance valve.

Boom Hoist Motor Bent axis motor with counterbalance valve.

Swing Motor High torque radial piston motor.

Travel Motor Bent axis motor with brake valve and spring-set/hydraulic-released multiplate disc brake.

Relief and Brake Valves Each hydraulic circuit incorporates large-capacity relief valves to protect circuit from overload or shock load. Counterbalance valves (compensates safe, positive load lowering and prevents accidental load drop when hydraulic power is suddenly reduced) are provided for hoist motor. Brake valves (consisting of relief valve and counterbalance valve) are provided for travel circuit.

Pressure Setting

MAIN CIRCUIT

- Main relief valves
 - Hoist (main and aux.) 300 bar
(300 kgf/cm², 4 270 psi)
 - Swing 210 bar
(210 kgf/cm², 2 990 psi)

- Overload relief valves
 - Hoist (main and aux.) circuit 305 bar
(305 kgf/cm², 4 340 psi)
 - Boom hoist circuit 265 bar (265 kgf/cm², 3 770 psi)
 - Travel circuit 280 bar (280 kgf/cm², 3 980 psi)

PILOT CIRCUIT

- Main relief valve 45 bar (45 kgf/cm², 640 psi)

Line Filters High filtration 10μ full-flow filter element is provided to keep hydraulic oil clean and ensure long-term, trouble-free operation. Pilot filter and suction filter are provided for each circuit.

CONTROLS

Boom, Main and Auxiliary Hoist and Travel Remote controlled hydraulic servo. Working speed can be precisely controlled by changing lever stroke.

Swing Mechanical linkage type.

Fuel Control Two foot throttle (accelerator) pedals and hand throttle (accelerator) controls equipped as standard.

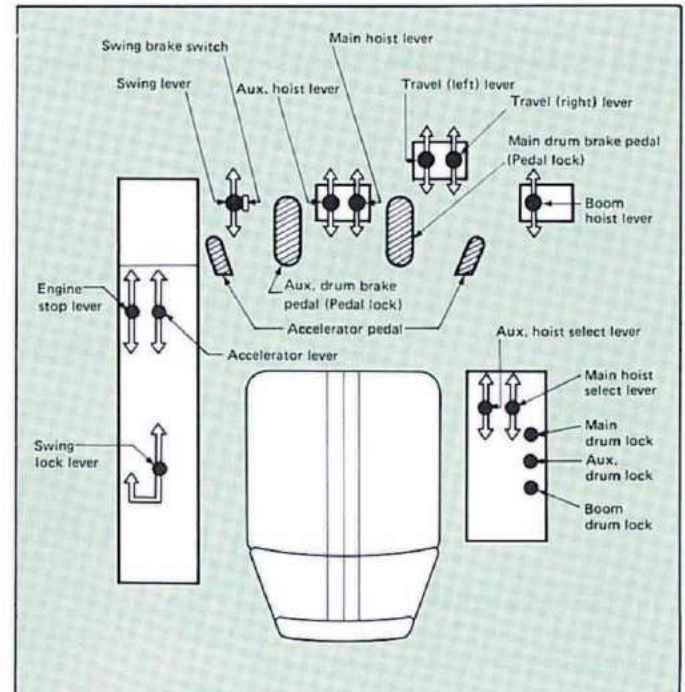

This monitor has the following functions

- **Instruments** Machine conditions are shown on meters.
- **Start up inspection monitor** To check the machine condition and safety device before starting operation.
- **Safety monitor** To warn the abnormality of the machine during operation and carelessness.



SAFETY DEVICES

Boom Angle Indicator Mechanical type boom angle indicator is provided at boom foot.

Counterbalance Valve (Brake Valve) A counterbalance valve is incorporated in travel motors, boom hoist motor, main and auxiliary hoist motor respectively. In case the hydraulic line is broken, this valve is automatically actuated to prevent motor rotation.

Spring-set/Hydraulic-released Multiplate Disc Type Travel Brakes

Swing Lock and Swing Parking Brake

Drum Lock A pawl type drum lock is adopted for main drum, auxiliary drum and boom drum.

For Lift Crane

- **Moment Limiter "Hi-Limiter"** The "Hi-Limiter" electrically detects the lifting load, and working radius from the boom angle. The detected data is calculated by a built-in micro-computer. When the lifting load reaches its alarm limit the "Hi-Limiter" buzzes, and when reaching the load limit, the control becomes inoperative.
- **Hook Overhoist Prevention Device** When the hook reaches its safety hoist limit, an alarm bell rings and an auto-stop device automatically actuates at the same time.
- **Boom Overhoist Prevention Device** When the boom reaches its safety angle limit, a buzzer alarm sounds and boom hoisting automatically stops at the same time. A telescopic type boom backstop is also installed.

SERVICE REFILL CAPACITIES

	Liters	Imp gal	U.S. gal
Fuel tank	250.0	55.0	66.0
Engine coolant	44.0	9.7	11.6
Engine oil	19.0	4.2	5.0
Pump transmission	2.7	0.59	0.71
Boom and winch hoist motor reduction device	5.6	1.2	1.5
Winch hoist motor reduction device	13.0	2.9	3.4
Swing reduction device	10.0	2.2	2.6
Travel final device (On each)	16.0	3.52	4.23
Hydraulic system (including tank capacity)	285.0	62.7	75.2
Hydraulic tank	205.0	45.1	54.1

OPTIONAL EQUIPMENT

Operator's Cab Electric fan, cab cooler

Third Drum

P.T.O. Driving a generator.

A built-in type lifting magnet or a welder can be installed.

Auxiliary Jib for Crane Boom Can be attached to the top of main boom for auxiliary hook-hoisting operation.

KH AND PD SERIES

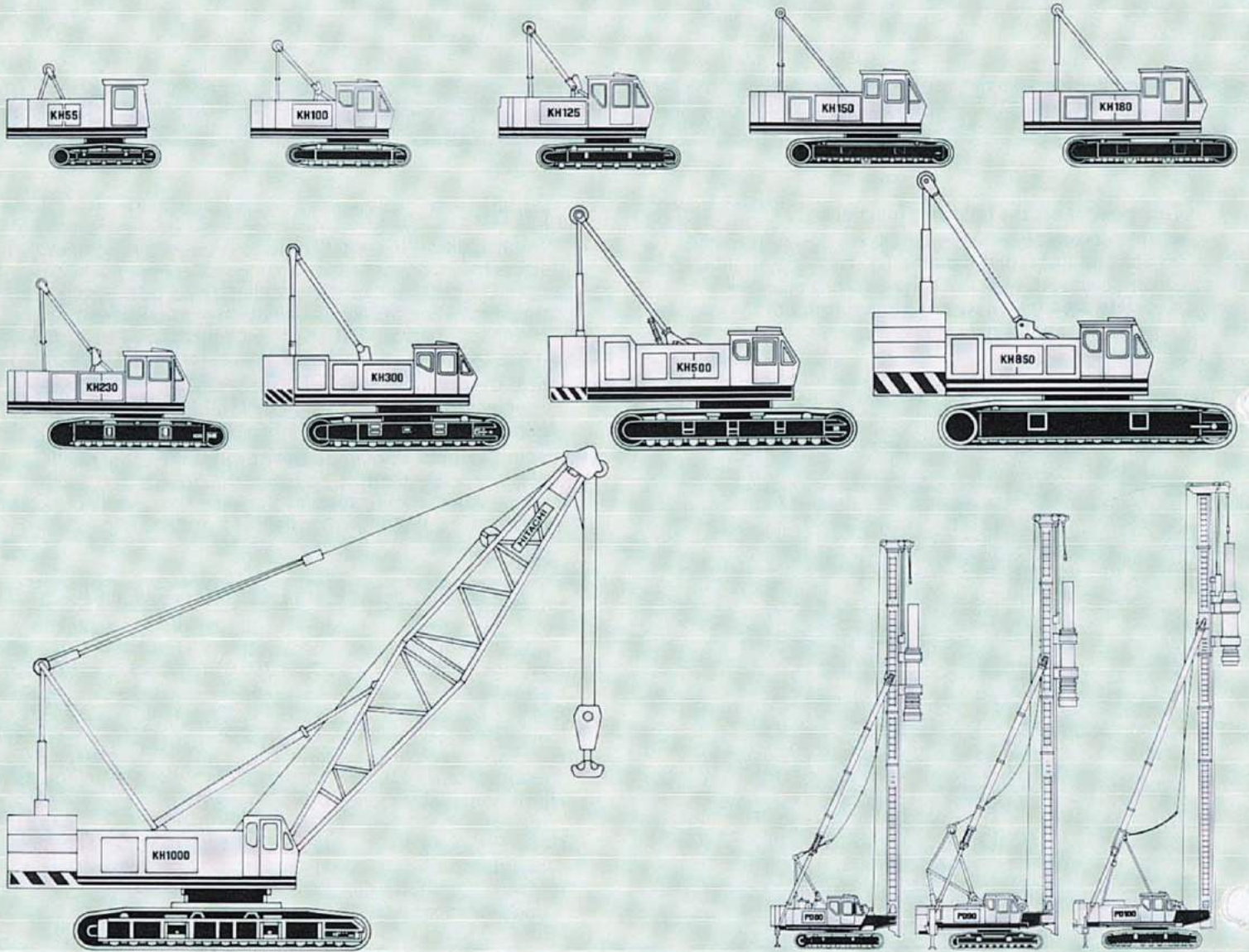

These specifications are subject to change without notice.

Hitachi Construction Machinery Co., Ltd.

Head Office: Nippon Bldg., 6-2, 2-chome, Ohtemachi,
Chiyoda-ku, Tokyo 100, Japan
Telephone: Tokyo (03) 3245-6377
Facsimile: Tokyo (03) 3246-2609
Telex: J 32539 HITACONJ
Cable Address: "TOKHITACHIKENKI"

Printed in Japan KH-H[F, H](HT3-SK, KF-F)